

Proteus™

PIPELINE CRAWLER INSPECTION SYSTEM



 **Mini-Cam**
InPipe Innovation



CRP300 Crawler
CAM028 Pan, Rotate & Zoom Camera
ALN300 Auxiliary Light
ALB300 Auxiliary Light/Backeye
QRW140SR/300 Soft Rubber Wheels

CONTENTS

INTRODUCTION	05	CABLE GUIDE PULLEY	38
SYSTEM CONFIGURATION	06	MANHOLE TOP ROLLER	38
PIPE DIAMETERS	08	CRAWLER CRADLE	39
CRAWLER FEATURES	10	CRAWLER CAMERA EXTENDER	40
CRAWLER RANGE	12	EXTRA WEIGHT PLATE	40
PROTEUS LITE	14	PORTABLE STORAGE TROLLEY	41
CONTROL UNIT	16	REMOTE CONTROLLERS	42
KEYBOARD FUNCTIONALITY	18	SEESNAKE® INTERFACE	42
REPORTING SOFTWARE	20	BRICK EGG STABILIZER	43
CAMERAS	22	CABLE REEL GUIDE	44
MOTORISED REELS	26	VAN GUIDE PULLEY	44
MANUAL REELS	28	CAMERA ELEVATION PLATFORM	45
LATERAL PIN KIT	30	REEL BRACKET	46
ROLLER SKIDS	30	PRESSURE KIT	46
COMPATIBLE COILER	31	PRO LASER	47
ATEX SYSTEMS	32	SPECIFICATIONS	48
CRAWLER WHEELS	34	MOBILE SERVICE SUPPORT	50
WIDE AXLE WHEELS	35	AFTER SALES SUPPORT	50
TILTING TABLE	36	PARTS E-SHOP	50
FLOATATION RAFT	36	HOW TO FIND US	51
BATTERY PACK	37	HOW TO CONTACT US	51



COVER IMAGE:

RAP300 Motorised Reel, **CCU208** Control Unit, **CRP300** Crawler, **QRW250** Pneumatic Balloon Wheels, **CAM028** Pan, Rotate & Zoom Camera, **ALN300** Auxiliary Light, **ALB300** Auxiliary Light/Backeye.



TRIED & TRUSTED OUR PROTEUS SYSTEM TICKS ALL THE BOXES!

With our experience of innovative solutions for the pipeline Inspection industry extending back over 20 years, we have created our most advanced, most capable, most feature-rich system. Proteus™ has been designed to meet your needs in the real world: a system which is highly affordable, reliable, and fully supported by experienced engineers and our “How To” video built-in support. The Proteus system is highly expandable and - most importantly - future proof.

All Proteus crawlers feature CAN bus technology, allowing communication directly between each piece of attached equipment, and can relay control and status information such as activity, speed, pressure, inclination and temperature.

The Proteus range includes a *Lite* system (page 15), which brings together, the well proven performance and reliability of the Proteus family, in a value for money, entry level system. Proteus Lite is the ideal starter kit for a one-man operation, integration into a small inspection van, or a low-cost option for larger companies to use for off-road, remote locations.

Designed and developed in-house, Mini-Cam’s Proteus crawlers are now one of the industry’s leading systems in daily use, both in the UK and in over 35 countries worldwide. The systems can be installed as part of our Custom Van-Fit service, or be fully portable with the Proteus Portable Storage Trolley (page 41) and the Proteus Power Battery Pack (page 37), giving up to five hours inspection time in a highly compact solution.





SYSTEM CONFIGURATION



ProPIPE+ Software
PAGE 20

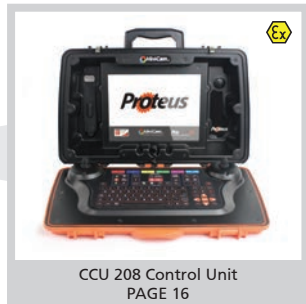

CCU 208 Control Unit
PAGE 16



WinCan Embedded
PAGE 20



WinCan Web
PAGE 20



Manual Reel
PAGE 28

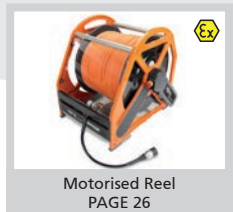

Motorised Reel
PAGE 26



CRP90 Crawler
PAGE 13



CRP140 Crawler
PAGE 12



CPL150 Crawler
PAGE 12



CRP150 Crawler
PAGE 12



CRP300 Crawler
PAGE 12



Floatation Raft
PAGE 36



Soft Rubber Wheel
PAGE 34



Wide Axle Wheel
PAGE 35



Carbide Wheel
PAGE 34

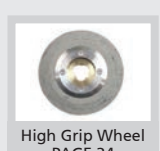

High Grip Wheel
PAGE 34

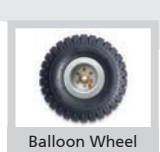

Balloon Wheel
PAGE 34

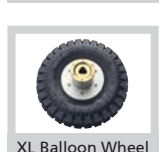

XL Balloon Wheel
PAGE 34



Auxiliary Light
PAGE 24



Auxiliary Light/Backeye
PAGE 24

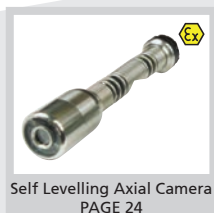

Self Levelling Axial Camera
PAGE 24



Pan & Rotate Camera
PAGE 25



Axial Camera
PAGE 24



Pan, Rotate & Zoom Camera
PAGE 25



Lateral Pin Kit
PAGE 30



CCP60R Compatible Coiler
PAGE 31

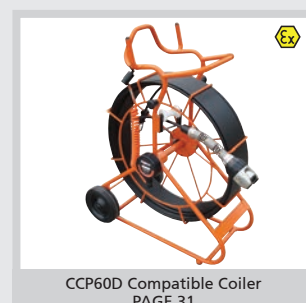

CCP60D Compatible Coiler
PAGE 31



Roller Skids
PAGE 30



Crawler Cradle
PAGE 39



Tilting Table
PAGE 36



Battery Pack
PAGE 37

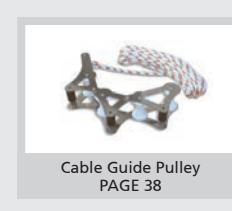

Cable Guide Pulley
PAGE 38



Manhole Top Roller
PAGE 38



Brick Egg Stabilizer
PAGE 43



Camera Elevation Platform
PAGE 45

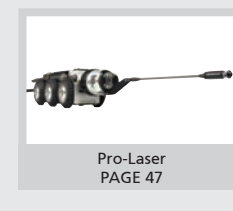

Pro-Laser
PAGE 47



Extra Weight Plate
PAGE 40



Crawler Camera Extender
PAGE 40



4 Button Remote
PAGE 42



Joystick Remote
PAGE 42



Pressure Kit
PAGE 46

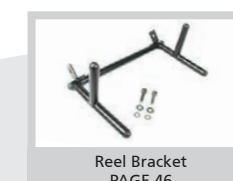

Reel Bracket
PAGE 46

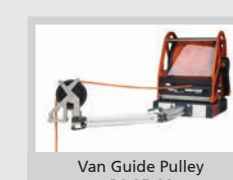

Van Guide Pulley
PAGE 44



Cable Reel Guide
PAGE 44



Seesnake® Interface
PAGE 42



Extension Reel



Link Cable

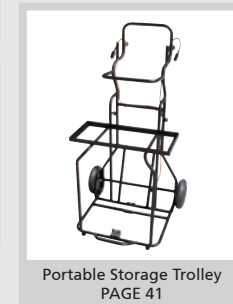

Portable Storage Trolley
PAGE 41

MINIATURE TO MASSIVE PROTEUS HANDLES THEM ALL!

With five crawlers, six cameras, two compatible coilers and over twenty accessories, the Proteus system can be configured to perfectly meet your requirements. As your business grows simply add more components from the Proteus range to your kit, enabling you to significantly increase your inspection capabilities for larger diameter pipes and tricky, challenging environments. No matter what the pipe diameter, Proteus crawlers are rugged, agile and rapidly responsive to your commands.

**START
PLANNING YOUR
PROTEUS SYSTEM**
CHECK OUT THE
CONFIGURATION
CHART ON
PAGE 06

The example shown here demonstrates the scope of the Proteus system. The compact size of our smallest CRP90 crawler allows it to easily survey relined 100mm pipes, while the CRP300 crawler, the largest in the range, with the optional CEP300 Camera Elevation Platform, centres the camera in an impressive 2200mm pipe diameter. For mid-size inspections, there are countless configurations possible with our CRP150, CPL150 and CRP140 Crawlers (page 12) - which one will you drive?

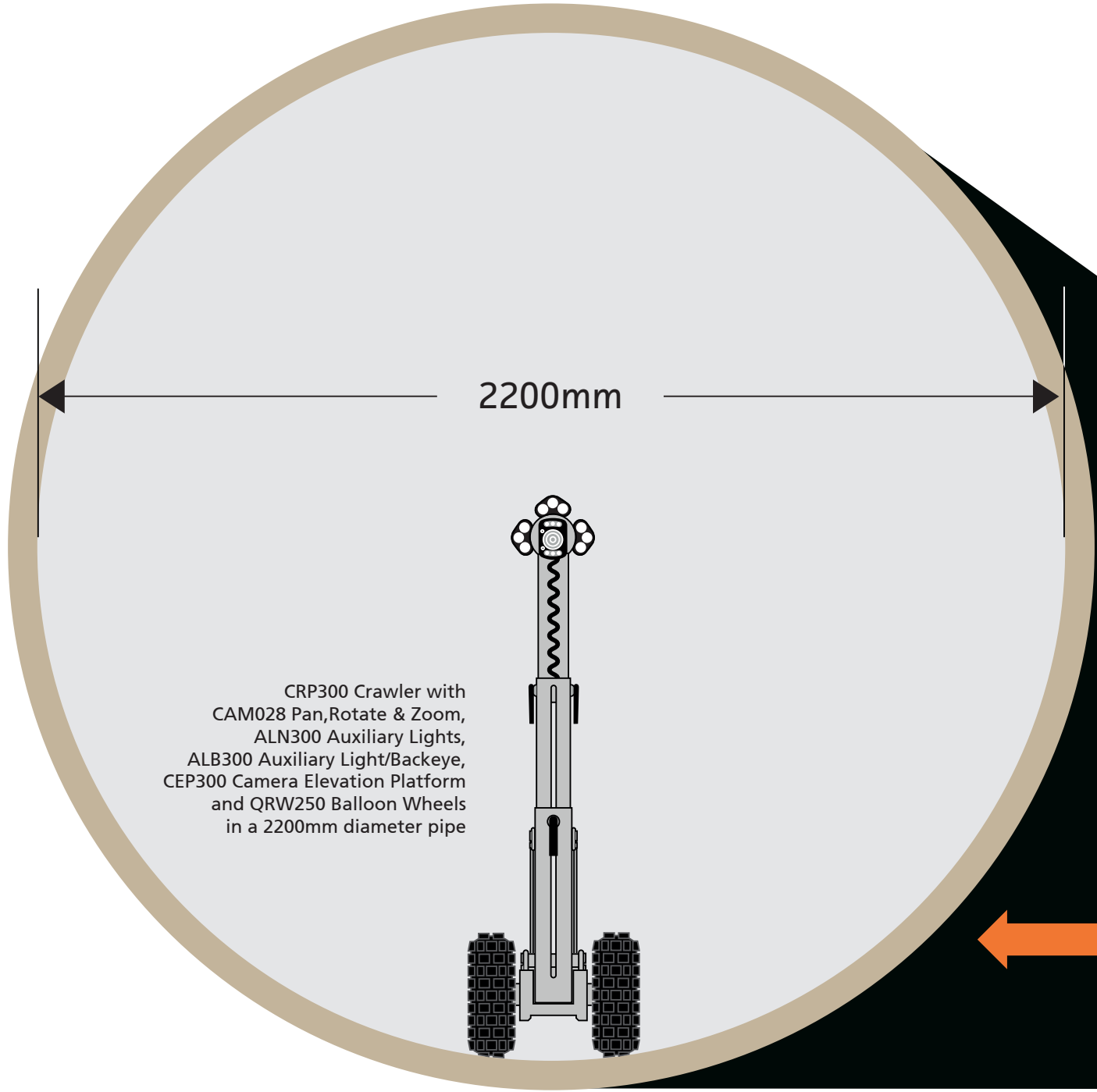

CRP300 Crawler with CAM028 Pan, Rotate & Zoom, ALN300 Auxiliary Lights, ALB300 Auxiliary Light/Backeye, CEP300 Camera Elevation Platform and QRW250 Balloon Wheels in a 2200mm diameter pipe

**PIPE DIAMETERS
FROM 100mm
TO 2200mm**

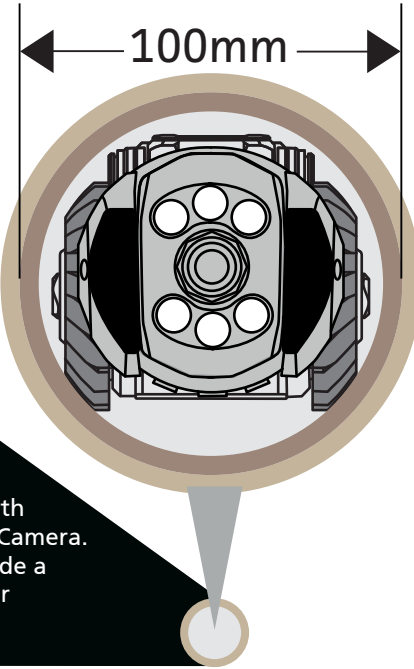

CRP90 Crawler with CAM026 Pan & Rotate Camera. Elevator Down, inside a 100mm diameter relined pipe.

PROTEUS FAMILY



A **CRP140** Crawler, **CAM028** Pan, Rotate & Zoom, **ALN300** Auxiliary Light
 B **CRP150** Crawler, **CAM026** Pan & Rotate, **ALB300** Auxiliary Light/Backeye
 C **CRP300** Crawler, **CAM028** Pan, Rotate & Zoom, Dual **ALN300** Auxiliary Lights
 D **CRP90** Crawler, **CAM027** Axial
 E **CPL150** Crawler, **CAM027** Axial

IN-BUILT INNOVATION

KEY FEATURES OF PROTEUS CRAWLERS

STANDARD FEATURES, OPTIONS & MODEL COMPARISONS ON NEXT PAGE



Quick Change Wheel Lock



Soft Rubber Wheels



In-built Inclination Sensor



Articulated Knuckle Connector

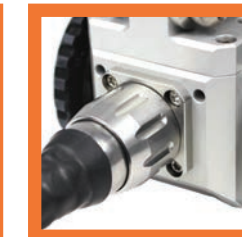

Heavy Duty Rear Connector



1 bar Pressure Tight



Auxiliary Light or Backeye Mounting



Heavy Duty Camera Connector



Motorised Elevator



Manual Elevator



Multi-Frequency Sonde 33kHz/512Hz/640Hz



Front Connector Protective Cap



Rear Connector Protective Cap

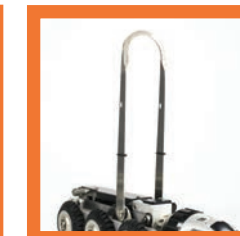

Lowering Arm



Lowering Arm



STANDARD FEATURES

- Compatible with:
 - CAM026 Pan & Rotate
 - CAM026L Pan, Rotate & Laser
 - CAM027 Axial
 - CAM028 Pan, Rotate & Zoom
 - ALN300 Auxiliary Light
 - ALB300 Auxiliary Light/Backeye
- Continuous monitoring of speed, internal pressure, inclination and temperature
- Dual Axis Inclination Sensor**
- Single Auxiliary Light/Backeye Mounting
- Multi-Frequency Sonde**
33kHz / 512Hz / 640Hz
- Steerable High Torque All-Wheel Drive
- Robust Housing
- 1 bar Pressure Tight
- Quick Change Wheel Lock
- In-Built Lowering Arm
- Heavy Duty Camera Connector
- Protective Connector Caps Front and Rear
- Lowering Rope
- Protective Carry Case*
- Tools

*Except CRP300 **Optional on CPL150

Ex ALL CRAWLERS ARE AVAILABLE IN ATEX ZONE 2 APPROVED VERSIONS - See page 32

CRP300

Engineered to perform reliably in challenging conditions

Designed for larger pipe diameters with high flow rates, this heavy duty crawler makes easy work of inspections in more difficult environments.

ALL STANDARD FEATURES INCLUDED PLUS

- 6 x QRWX140SR 140mm Rubber Wheels
- Motorised Elevator - Range 135-398mm
- Heavy Duty Rear Connector

OPTIONAL

- Wide Axle Balloon Wheels (page 34)



Technical Specifications	
Product Code	CRP300
Pipe Sizes	from 300mm - 1000mm to 2200mm with Elevation Platform CEP300 (page 45)
Weight	32.0kg

CRP150

Highly flexible, modular mid-size crawler

For pipes from 150mm up to 600mm. With the optional PCC01 Crawler Cradle it can even be used in pipes up to 1000mm diameter.

ALL STANDARD FEATURES INCLUDED PLUS

- 6 x QRWX90SR 90mm Rubber Wheels
- Manual Elevator - Range 70-257mm
- Heavy Duty Rear Connector

OPTIONAL

- Carbide Wheels (page 34)
- High Grip Wheel (page 34)



Technical Specifications	
Product Code	CRP150
Pipe Sizes	from 150mm - 600mm to 1000mm with PCC01 Crawler Cradle (page 39)
Weight	9.25kg

CPL150

Entry level, mid-size crawler with manual elevator

The perfect companion to the RMPL250 Reel (page 15). CPL150 has the same professional grade quality, reliability and accuracy as our mainline Proteus crawlers.

ALL STANDARD FEATURES INCLUDED PLUS

- 6 x QRWX90SR 90mm Rubber Wheels
- Manual Elevator - Range 60-112mm
- Heavy Duty Rear Connector

OPTIONAL

- Multi-Frequency Sonde
- Inclination Sensor
- Carbide Wheels (page 34)
- High Grip Wheel (page 34)



Technical Specifications	
Product Code	CPL150
Pipe Sizes	from 150mm - 400mm to 800mm with PCC01 Crawler Cradle (page 39)
Weight	9kg

CRP140

Sophisticated mid-size crawler modelled on the CRP150

For pipes from 140mm (even in a relined pipe) up to 600mm, with the optional PCC01 Crawler Cradle it can even be used in pipes up to 1000mm diameter.

ALL STANDARD FEATURES INCLUDED PLUS

- x QRWX90SR 90mm Rubber Wheels
- Motorised Elevator - Range 54-205mm
- Articulated 'Knuckle' Connector

OPTIONAL

- Carbide Wheels (page 34)
- High Grip Wheel (page 34)

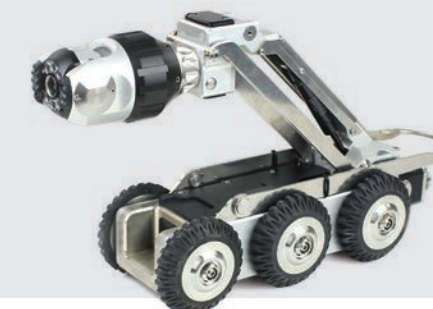

Technical Specifications	
Product Code	CRP140
Pipe Sizes	from 140mm - 600mm to 1000mm with PCC01 Crawler Cradle (page 39)
Weight	9.5kg

CRP90

Massive capabilities Skilfully miniaturised

CRP90's compact size allows it to easily survey relined 100mm pipes. The motorised elevator enables the camera to be centred in pipes of up to 225mm diameter.

ALL STANDARD FEATURES INCLUDED PLUS

- 6 x QRWX60SR 60mm Rubber Wheels
- Motorised Elevator - Range 40-77mm
- Articulated 'Knuckle' Connector

OPTIONAL

- Carbide Wheels (page 34)
- High Grip Wheel (page 34)



Technical Specifications	
Product Code	CRP90
Pipe Sizes	90mm - 225mm
Weight	4.50kg

PROVEN RELIABILITY MODULAR CAPABILITY

Mini-Cam's *Proteus Lite* brings together, the well proven performance and reliability of the Proteus family, in a value for money, entry level system.

Designed and developed in-house, Proteus Lite is the ideal starter kit for a one-man operation, integration into a small inspection van, or a low-cost option for larger companies to use for off-road, remote locations. Proteus Lite provides all the resources required to undertake efficient, easy to perform inspections, and with *ProPIPE+*, *WinCan Embedded* and *WinCan Web* software as standard, you can deliver accurate, detailed reports, instantly on-site.

Future proof and totally modular, when your business budget allows, simply upgrade your Proteus Lite with a larger or smaller crawler, extra cameras and auxiliary lights, or one of the many other Proteus compatible accessories available.



CPL150 Crawler



Proteus Lite System

RMPL250 Reel

- 250m Kevlar Reinforced Cable
- Manual Cable Layering Arm
- 2-Step Quick-Release Meterage Rollers - removable for easy cleaning
- Friction Brake
- Removable Winding Handle
- Spring Loaded Connector
- Powder Coated Frame with Rubber Feet
- Unique Cow Horn locator for easy-fit Control Unit (CCU)

CPL150 Crawler

- Quick-Adjust Manual Elevator
- Lowering Handle
- Heavy Duty Rear Connector
- 6 Soft Rubber Wheels
- Quick-change Wheel Lock

CAM026 Pan & Rotate Camera

See page 25

CCU208 Control Unit

See page 17



Quick-Adjust Manual Elevator



Lowering Handle



Manual Cable Layering Arm

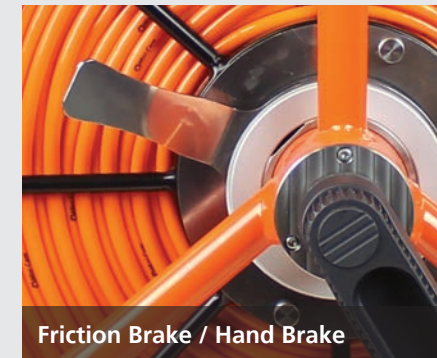

Friction Brake / Hand Brake



2-Step Quick Release Meterage Rollers



Fold-away/Removable Handle

MUCH MORE THAN MEETS THE EYE.

Feature rich, Mini-Cam's CCU208 Control Unit has twin integral joysticks for camera control and crawler manoeuvrability, and an ergonomic soft-touch keypad. User friendly multi-function hot keys control an intuitive on-screen display, to enable quick and accurate navigation of the numerous features which all come as standard on the brain of the Proteus system.

Functionality at your fingertips.



FUNCTIONALITY AT YOUR FINGERTIPS

Use the Proteus control unit to view, record and annotate inspection footage from any composite video source.

Control Meterage

Accurately set the meterage zero offset using the meterage key.

00.0

Sonde Settings

Set the frequency of the sonde transmitter to 33kHz, 512Hz or 640Hz.



Hot Keys

User friendly, multi-function hot keys control an intuitive on-screen display of the numerous features.



Survey Features

Access embedded reporting software to create detailed on-site reports



Generate Reports

Use ProPIPE+ Reporting software to create a detailed inspection report with a pipe graph to pinpoint defects.

PDF

Internal Batteries

The Proteus CCU includes internal batteries so that it can be used autonomously to view inspection reports and video.

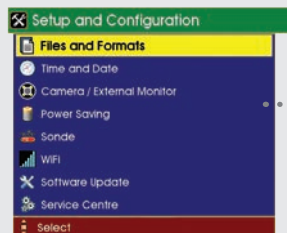
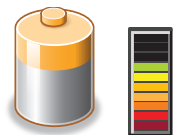

Setup & Configure Preferences

Easily and quickly configure the Proteus CCU to your specific requirements using the various menu options. Set language, date and time; establish file formats and naming conventions; adjust camera parameters; choose interface theme, enable power saving options and update firmware.



Capture Footage

Record MPEG video and JPEG images, and zoom up to 3X on video playback.



Write Screen Text

Type and store up to 16 pages of on-screen text. Customize text colour, position and background colour.

T

16

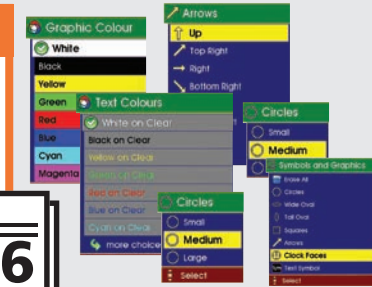

Joystick Controls

The left hand joystick controls crawler manoeuvrability. Movement of the Pan & Rotate camera is smooth and effortless using the right hand joystick control. Perform a 360° endless rotation and pan the camera +/- 135°.



Share Files

WiFi enabled to allow remote access to stored images and data. Users can instantly share PDF reports, images and footage via email, or upload WinCan Reports via the Cloud to WinCan Web for secure, immediate team-wide access online.



Illumination

Increase or decrease the intensity of the ultra-bright camera LEDs

Alternative Languages

Proteus is currently available with keyboards in English, French, German and Russian

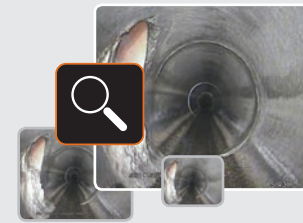

Review Footage

Organize videos and images into folders, then find them using the thumbnail gallery. Review media using standard controls.



Screens Intensity

The brightness, colour and backlight intensity of the internal display can be adjusted to suit the environment in which the system is being used.



Offload Data

Copy reports, video and images to USB or SDHC media for easy transfer to PC and seamless integration with WinCan reporting and querying capabilities.



REPORTING SOFTWARE

ProPIPE+ reporting software, developed by our in-house team of software engineers, enables accurate inspection of sewers with easy post-processing of inspection data. The newly released version generates PDF files and allows users to create professionally presented, detailed reports with illustrated pipe graphs and screen shots, and also features a file sharing feature (see opposite)

Uncomplicated and efficient, ProPIPE+, WinCan Embedded and WinCan Web software is pre-installed as standard on the Proteus control unit, giving the ability to create comprehensive inspection reports on site and instantly share them with colleagues and customers. This gets the results to the client faster, making your business ultra efficient, reducing your administration costs and eliminating those long hours in the office.

Mini-Cam's Proteus control unit is WiFi enabled to allow remote access to stored images and data. Users can simply drag and drop files from control unit to PC, or upload to the Cloud directly on-site. ProPIPE+ doesn't require any additional software to view reports on a PC, simply open the file in Microsoft® Word.



ProPIPE+ and WinCan Embedded software comes pre-installed as standard on Proteus systems



- SAVE TIME AND MONEY
- CREATE A FULL REPORT INSTANTLY, ON-SITE
- ABILITY TO CREATE CUSTOMER SPECIFIC REPORT TEMPLATES
- GENERATE PDF REPORTS
- RE-DESIGNED PAGES FOR EASIER READING
- DETAILED PIPE GRAPH PINPOINTS DEFECTS
- SHARE FILES VIA EMAIL



- DATABASE CAPABILITIES
- WRc3, WRc4 & WRc5 COMPLIANCE
- GIS INTEGRATION
- ADVANCED TECHNOLOGY MODULES
- ENHANCED REPORTING
- SUPPORT FOR NETWORK INSTALLATION
- SUPPORT FOR ENTERPRISE DATABASE (Oracle, SQL)



- SHARE FILES WITH COLLEAGUES & CUSTOMERS
- SHARE PDF REPORTS, IMAGES & FOOTAGE VIA EMAIL
- UPLOAD WINCAN REPORTS VIA THE CLOUD TO WINCAN WEB



SHARE FILES



The latest release of ProPIPE+ Reporting Software and WinCan Embedded now includes the new File Share feature. Quick and simple to use, with just a 3-step menu selection, users can instantly share PDF reports, images and footage via email, or upload

WinCan Reports to WinCan Web for secure, immediate, team-wide access online. All that is required to start sharing with colleagues and customers is a 3G or 4G Wi-Fi connection. Users can create the hot-spot using their smartphone.

YouTube View ProPIPE+ footage on our YouTube Channel - MinicamTubeUK



PRECISION CAMERAS FOR OPTICAL EXCELLENCE

Highest quality components are used in our camera designs, and our skilled technicians assemble and rigorously test the cameras at our UK production facility. Built for longevity, the cameras are rugged, with robust and precise connectors, and are engineered to perform with excellent optical qualities.



CAM028 Pan, Rotate & Zoom Camera with Dual Lasers for diameter and defect measurements



CAM025 AXIAL CAMERA

A Mini-Cam best seller, the CAM025 Self-Levelling Axial camera performs reliably in daily use. The stainless steel housing with flexible spring and heavy duty connector

features four high powered, ultra-bright LED lights and a hard wearing, scratch resistant sapphire glass to protect the camera lens.



Axial Camera

Product Code	CAM025
--------------	--------

See page 49 for technical specification

PAN & ROTATE CAM026

Mini-Cam's CAM026 Pan & Rotate camera features continuous 360° rotation and +/-135°pan. Our signature dual clusters of three high powered

ultra-bright LED lights provide optimum illumination for better clarity of images, and hard wearing, scratch resistant sapphire glass protects the camera lens.



Pan & Rotate Camera

Product Code	CAM026
--------------	--------

See page 49 for technical specification



Selected cameras from Mini-Cam's range are available in ATEX Zone 2 Certified versions (page 32)



CAM027 Axial Camera



ALN300 Auxiliary Light



ALB300 Aux Light with Backeye



CAM028 PAN, ROTATE & ZOOM CAMERA

Designed and manufactured to our enviable standards, the big-brother to our smaller CAM026 Pan and Rotate this larger, rugged built camera features our signature dual clusters of three powerful, ultra-bright LEDs for maximum illumination, and dual lasers for diameter and defect measurement. Shutter-free horizontal and vertical viewing is smooth and easy with the full 360° pan and rotate function, and our unique quick install connector makes getting ready for pipeline inspection as easy as twist-and-lock.

MOTORISED REEL RAP300•200



BLUETOOTH® CONTROLLERS



RJP Joystick Controller



RCP4 4 Button Controller



Built to the same exacting standards as our manual cable reels, these labour saving motorised reels are sturdy, rugged and built to perform reliably efficient pipeline inspections.

Mini-Cam motorised cable reels are designed for easy one-person operation in remote locations. The reels are fitted with high tensile strength Kevlar reinforced inspection cable. The ultra-smooth operation is provided by the powerful three phase motor and cable layering mechanism for uninterrupted, tangle free pay-out and re-winding. A rigid, clear safety screen prevents contact with the cable whilst coiling.

The reel is operated using the dedicated keys and intuitive on-screen display on the Proteus CCU.

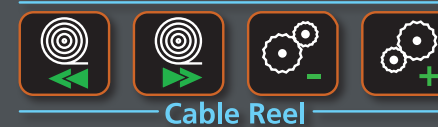

Cable Reel

In the event of an emergency, the reel also features an emergency stop button. The specialised crawler connector provides a waterproof seal and there's a removable drip tray for easy cleaning and maintenance.

Two optional hand-held Bluetooth® controllers are available to remotely control paying-out and rewinding cable, and crawler movement. Choose from the 4 button or Joystick version.

Motorised reels are available in 2 sizes – Large 300m and Small 200m. The 200m reel has secure fixing points for fitting to our PTP01 Portable Storage Trolley (see page 41). Both reels are ideal for being installed in our SurveyPro CCTV Van Fit.

For more information on Mini-Cam Custom Van-fits visit minicam.co.uk/custom-van-fits

Cable available in ATEX ZONE 2 Approved



Emergency Stop Button



Cable Self-Layering Mechanism

Technical Specifications

Product Code	RAP200	RAP300
Cable Length	200metres	300metres
Dimensions LxWxH mm	530 x 320 x 520	530 x 440 x 520
Weight	32.5kg	42.5kg
Power Supply	24v	24v
Environmental Protection	IP54	IP54
Optional Remote Controller	RJP/RCP4	RJP/RCP4

MANUAL REEL RMP300•200•100

Sturdy, rugged and built to withstand harsh environments. Mini-Cam manual cable reels are compact, portable and easy to use. The robust powder coated frame houses high tensile strength Kevlar reinforced inspection cable.

Smooth pay-out and re-winding is performance enhanced by the cable layering mechanism and durable heavy duty turning handle. The specialised crawler connector provides a water-proof seal and there's a removable drip tray for easy cleaning and maintenance.



The reels are available in 3 sizes: small 100m, mid-size 200m and large 300m reels. The small and mid-size reels can be fitted to our Portable PTP01 Storage Trolley (shown right) and on page 41, and the large reel is ideal for being installed as part of our SurveyPro CCTV Van. For more information on Mini-Cam Custom Van-fits visit minicam.co.uk/custom-van-fits

 Cable available in ATEX ZONE 2 Approved

Technical Specifications			
Product Code	RMP100	RMP200	RMP300
Cable Length	100metres	200metres	300metres
Dimensions LxWxH mm	530 x 220 x 520	530 x 280 x 520	530 x 400 x 520
Weight	18kg	27kg	37kgs
Environmental Protection	Splash Proof	Splash Proof	Splash Proof



LATERAL PIN KIT

Smooth inspection of incoming laterals

For use with the CAM026 Pan & Rotate camera when attached to the CCP60/100 Compatible Coiler. Simply attach the pin to allow the inspection of incoming lateral pipes. The pin adjusts the direction, and guides the camera smoothly along the pipe. The kit comes with three sizes of pin: small 150mm, medium 225mm and large 300mm. Fixings and instruction included.

COMPATIBLE COILER ACCESSORY



ROLLER SKIDS

Optimize your view

Roller skids expand the Compatible Coiler for use in 150mm to 450mm pipelines. The three pivoting arms with specially shaped nylon wheels adjust to fit the required pipe diameter, keeping the camera head centred in the pipeline at all times, allowing it to negotiate multiple corners and bends. Manufactured from stainless steel and ABS plastic, the device is sturdy, rugged and corrosion resistant to withstand the punishment of daily field work. No tools or manual adjustments are required

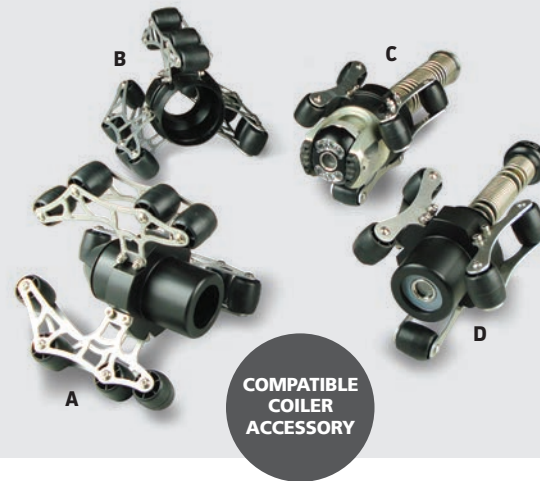

COMPATIBLE COILER ACCESSORY

COMPATIBLE COILER

Companion accessory to the Proteus system

Push rod coiler CCP60R with removable CAM025 Self Levelling Axial camera head, designed to plug directly into the Proteus CCU. Also available as CCP60D (Duo) allowing a CAM026 Pan & Rotate camera to be attached. Robust construction with mobility wheels and a durable powder coated finish.

Centering skids optimize your view in pipes 75mm and larger. The CCP coiler comes complete with a set of three skids and a removal tool.



COMPATIBLE COILER



AVAILABLE WITH 60 METRE OR 100 METRE ROD LENGTHS

A Compatible Coiler with CAM026 Pan & Rotate
B Compatible Coiler with CAM025 Axial Camera

Technical Specifications

Product Code	ASS-001-968
Small Pin Length	150mm
Medium Pin Length	225mm
Large Pin Length	300mm
Fixings Supplied	6 Screws

Technical Specifications

Compatibility		Product Code
A	180mm Skid for CAM025	ASS-002-009
B	180mm Skid for CAM026	ASS-001-955
C	130mm Skid for CAM026	ASS-002-160
D	130mm Skid for CAM025	ASS-002-008

Centering Skids

Supplied with CCP60/100	
C	4inch Skid
D	6inch Skid
E	Protection Skid
F	Skid Removal Tool

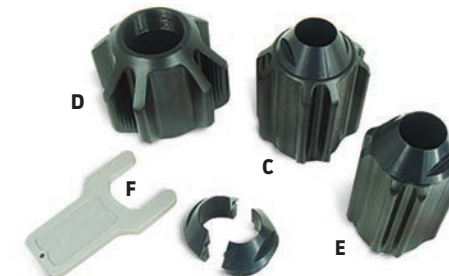

Technical Specifications

Product Code	CCP60 / CCP100
Temperature Range	-20°C ~ +50°C
Dimensions H x W x D	890 x 360 x 690mm
Weight (without CCU)	21.3kg
Environmental Protection	IP54

ATEX CAMERAS



CAM026EX

ATEX Pan & Rotate Camera



CAM028EX

ATEX Pan, Rotate & Zoom Camera



ALB300EX

ATEX Auxiliary Light/Backeye

**EASY
DEPLOYMENT
AND RETRIEVAL**Using the in-built
lowering device**BACK-EYE
CAMERA**Capture images
from behind
the camera**PAN &
ROTATE**360° continuous
rotation and
+/- 135°Pan**DUAL
AUX LIGHTS**Optimum
illumination for
image clarity**KEEP ON
TRACK**Heavy duty
250mm pneumatic
balloon wheels

ABOVE: CRP300EX Crawler, CAM026EX Pan, Rotate Camera,
ALN300 Auxiliary Light, ALB300 Auxiliary Light/Backeye,
QRW250 Pneumatic Balloon Wheels.

ATEX APPROVED

UNCOMPROMISING PERFORMANCE AND SAFETY



Proteus™ ATEX crawlers have been engineered, built and tested for safe use in some of the most dangerous situations, without compromising on any of the features and benefits of our other Proteus crawlers. All our crawlers are available in ATEX approved versions which make working in ZONE 2 and other explosion-risk environments much easier and safer than alternative methods, giving you a clear, sharp eye into the unknown, without introducing risk through use of electronic devices.

ATEX crawlers have all the features, functionality and agility of the standard versions, and offer the same professional-grade quality, reliability and accuracy our customers expect from the Proteus brand.

The Proteus ATEX crawlers feature as standard: built-in height adjustment, multi-frequency SONDE, lowering device, and variable wheel size options using our unique quick-release locking system.

RIGHT: CRP150EX Crawler
CAM026EX Pan & Rotate Camera
QRW140HG/150 140mm High Grip Wheels
QRW90R/150 90mm Soft Rubber Wheels



CRAWLER WHEELS



Our specially designed wheels offer significant performance benefits in various pipe diameters and for specific operating conditions.

SOFT BLACK RUBBER

Black, soft rubber tyres developed to provide improved traction in regular pipes.

Available in four sizes and Wide Axle



IMPROVED TRACTION



HIGH GRIP

Hard wearing carborundum manufactured with a deep bevel profile to provide improved traction in wet and greasy pipes.

Available in three sizes and Wide Axle



FOR WET & GREASY PIPES

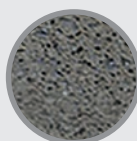

CARBIDE

Fragmented copper particles fused to an heavy duty stainless steel body.

Available in four sizes and Wide Axle



FOR PLASTIC PIPES



PNEUMATIC BALLOON

Heavy duty, 250mm wide tyres designed to improve performance on our large Proteus CRP300 crawler. Optional for Crawler Cradle PCC01.

Available in one size and Wide Axle



RUGGED HEAVY DUTY

QUICK RELEASE LOCK

Proteus crawlers feature Mini-Cam's unique, patented wheel lock device. This makes it easy to change the crawler wheel type to suit the size and condition of the pipe. Using the supplied 4mm Hex T-Bar driver, the operation is quick and simple with no other tools required.

[YouTube](#) View the Changing Wheels "HOW-TO" video at [MinicamTubeUK](#)



WIDE AXLE WHEELS

Extend the capability of your crawler. Quick and easy to attach, wide axle wheels provide instant extra width for inspections in wider pipe diameters.

Wide axle wheels are available in Soft Black Rubber, Carbide and High Grip

Wheel Type	To fit CRP90	To fit CRP150/CPL150	To fit CRP300	Recommended Pipe Diameter
Soft Black Rubber Wheels				
60mm Wheel	QRW60SR/90	-	-	100mm
90mm Wheel	QRW90SR/90	QRW90SR/150	-	150mm
90mm Extra Large Wheel	QRW90XLSR/90	-	-	150mm
115mm Wheel	-	QRW115SR/150	-	200 to 300mm
140mm Wheel	-	QRW140SR/150	QRW140SR/300	300 to 450mm (150) 300 to 600mm (300)
140mm Extra Large Wheel	-	QRW140XLSR/150	-	450 to 600mm
Carbide Wheels				
60mm Carbide Wheel	QRW60CB/90	-	-	100mm
90mm Carbide Wheel	QRW90CB/90	QRW90CB/150	-	150mm to 200mm (90) 150mm (150)
90mm Extra Large Carbide Wheel	QRW90CBXL/90	-	-	200mm to 300mm (90)
115mm Carbide Wheel	-	QRW115CB/150	-	200mm to 300mm
140mm Carbide Wheel	-	QRW140CB/150	-	300mm to 450mm
High Grip Wheels				
90mm High Grip Wheel	QRW90HG/90	QRW90HG/150	-	150mm to 200mm
90mm Extra Large High Grip Wheel	QRW90HGXL/90	-	-	200mm to 300mm
115mm High Grip Wheel	-	QRW115HG/150	-	200mm to 300mm
140mm High Grip Wheel	-	QRW140HG/150	-	300mm to 450mm
Pneumatic Balloon Wheels				
250mm Wheel	-	-	QRW250	600mm to 1000mm
250mm Extra Large Wheel	-	-	QRW250XL	600mm to 1000mm

RIGHT: CRP150EX Crawler
CAM026EX Pan & Rotate Camera
QRW140HG/150 140mm High Grip Wheels
QRW90R/150 90mm Soft Rubber Wheels



CCU TILTING TABLE

Customise the CCU position to suit the needs of the user

Quick and easy to attach, the *Tilting Table* allows adjustment of the control unit position, to give the user optimal screen viewing and keyboard positions. The table can be tilted 35° forwards and 75° backwards, with a full unobstructed 360° horizontal rotation. No tools are required, simply attach using the adjustable clamps.



You Tube
View on our YouTube Channel
MinicamTubeUK

Technical Specifications	
Product Code	TTC01
Dimensions LxWxH	350 x 300 x 270mm
Weight	3kg

FLOATATION RAFT

Pipe inspection in flowing water just got easier!

Eliminate the need for man-entry. The raft features three powerful angled auxiliary LED ultra-bright light modules, to illuminate pipes in excess of 2000mm. Small enough to be lowered down most common sizes of manhole cover, the compact design allows inspection capabilities in pipes from 600mm. An in-built lowering loop makes for quick and easy deployment and retrieval, and the floatation plate ensures the device is perfectly balanced to eliminate rolling.

SIMPLY PLUG & PLAY* WITH AN EXISTING PROTEUS SYSTEM

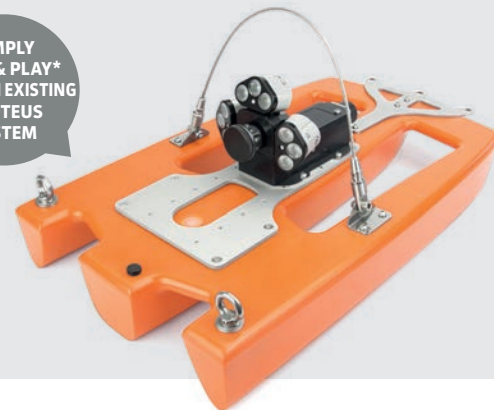

Technical Specifications	
Product Code	FRP01
Dimensions LxWxH	680 x 420 x 200mm
Weight (without camera)	5.8kg
IP Rating	IP68

*Additional software may be required

PROTEUS POWER BATTERY PACK

Portable power... where will it take you?

No need to rely on vehicle or mains power. Mini-Cam's unique Proteus Power Battery Pack enables pipeline inspections in the most remote locations with in excess of 5 hours inspection time*. The rugged pack is quick



Please Note: Charging unit shown above for illustration only, not included with Proteus Power Pack. Charging Unit purchased separately. *Battery life dependant on operating conditions.

Technical Specifications	
Product Code	BPP24
Dimensions L x W x H	280 x 100 x 120mm
Weight	4kg
Optional	Carry Case

Dangerous goods shipping conformity required - please contact us for details



and easy to connect and features output short circuit protection and LED charge status indication. The battery is charged using the standard Proteus power supply unit.

You Tube
View on our YouTube Channel
MinicamTubeUK



OPTIONAL EASY ACCESS CARRY CASE

CABLE GUIDE PULLEY

For smooth guiding of inspection cable during survey

Reduces wear by preventing kinks and chaffing, and assists in the smooth guiding of inspection cable during your survey. Comes complete with 12metres of rope and features a quick release mechanism to aid feeding the cable through the rollers.

QUICK RELEASE MECHANISM

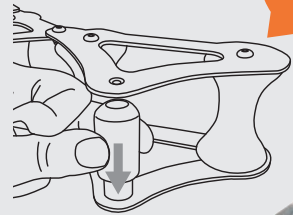

MANHOLE TOP ROLLER

For smooth guiding of inspection cable during survey

Reduces wear by preventing kinks and chaffing, and assists in the smooth guiding of inspection cable during your survey. Fully adjustable to fit most manhole sizes.



Technical Specifications

Product Code	CGP01
Dimensions LxWxH	485 x 75 x 105mm
Rope Length	12metres
Weight (inc rope)	2.8kg

Technical Specifications

Product Code	TRP01
Dimensions LxWxH	650 x 290 x 140mm
Weight	4.45kg

CRAWLER CRADLE

Improved inspection capabilities

The *Crawler Cradle* adapts Mini-Cam's CRP150, CPL150, and CRP140 crawlers for use in large diameter pipes. Versatile, quick and easy to attach, the cradle provides extra ground clearance enabling improved inspection capabilities in pipes and culverts up to 1000mm in diameter.

This robust, steerable, 4-wheel drive cradle is driven by the crawler, and features a unique gear selector, enabling the user to change between high speed and high torque operation. Exclusively compatible with Proteus CRP150, CPL150, and CRP140 crawlers, PCC01 comes supplied with four 220mm balloon wheels.

YouTube
View on our
YouTube Channel
MinicamTubeUK



For heavily silted pipes we recommend the optional 250mm Balloon Wheel (QRW250/150), which are also required to centralise the crawler in 1000mm diameter pipes.



UNIQUE GEAR SELECTOR



Technical Specifications

Product Code	PCC01
Compatibility	CRP150 / CPL150 / CRP140
Dimensions LxWxH	410 x 265 x 220mm
Weight	7.6kg
Fixings	2 Axle Adaptors & Bolts

CRAWLER CAMERA EXTENDER

Extends the camera position 100mm forwards

The *Crawler Camera Extender* moves the camera position 100mm forwards, extending the camera beyond the crawler. When the camera is positioned 90° downwards, this provides a view of the invert of pipeline, and not the crawler.

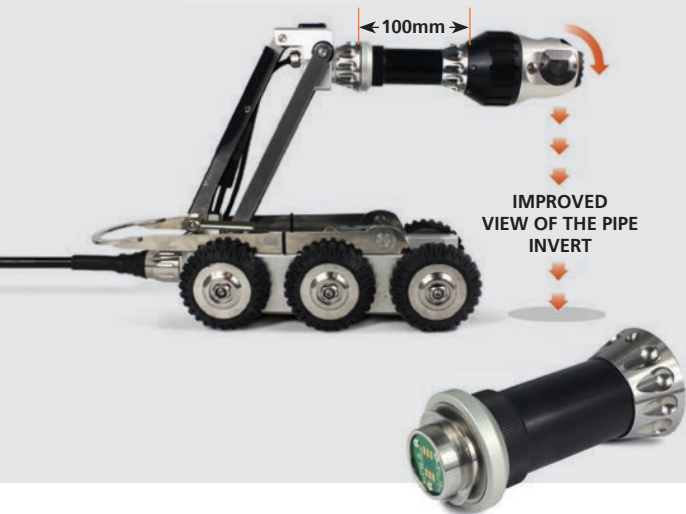

Technical Specifications

Product Code	CCE01
Dimensions LxWxH	115 x 50 x 50mm
Weight (inc rope)	302g

EXTRA WEIGHT PLATE

Extra downforce and traction for the crawler

Exclusively compatible with Proteus CRP150, CPL150 and CRP140 crawlers, the 2.5kg *Extra Weight Plate* gives the crawler extra downforce to allow for more traction in tricky pipe conditions. Quick to attach, the assembly is supplied with fixing bolts and washers.



Technical Specifications

Product Code	EWP01
Compatibility	CRP150 / CPL150 / CRP140
Dimensions LxWxH	264 x 80 x 14mm
Weight	2.5kg
Supplied with	Fixing Bolts & Washers

PORTABLE STORAGE TROLLEY

Complete mobility for your Proteus system

Eliminate health hazardous lifting, and time consuming carrying to your remote work site. Engineered to allow for the mobile operation of your Proteus Inspection System in difficult to reach areas, such as inside buildings, or other situations a distance away from your vehicle. The trolley securely holds everything you need to efficiently undertake your pipeline inspection. Simply wheel the unit to your location, connect a camera and crawler and you're up and running in minutes. With the added convenience of Mini-Cam's unique Proteus Power Pack (see page 37), there's no need to rely on generator or mains power. The power pack enables pipeline inspection in the most remote locations with up to 5 hours* inspection time.



Designed with simplicity in mind, the portable trolley will hold a Control Unit, Manual 100/200m or Motorised 200m Cable Reel, Proteus Power Battery Pack and a Protective Accessory Case, making the full Proteus system highly portable and suitable for one-man operation in remote locations.

Technical Specifications

Product Code	PTP01
Dimensions WxHxD	650 x 1150 x 750mm
Weight (unladen)	9.75kg

Please Note: Equipment shown on trolley not included with PTP01
*Battery life dependant on operating conditions.

REMOTE CONTROLLERS

Instant control with Bluetooth® wireless connectivity

The *4 Button Remote Control* and *Joystick Remote Control* are used to control a Crawler and Motorised Cable Reel using Bluetooth® wireless technology. The Motorised Cable Reel can be controlled directly without the presence of the Control Unit. A handy size and lightweight, the controllers are simple to use and have an internal battery life in excess of 2 years. Supplied with full instructions.



RCP4 4 Button Controller

RJP Joystick Controller

Technical Specifications

Product Code	RCP4	RJP
Compatibility	RAP300/RAP200	RAP300/RAP200
Dimensions W x L x D mm	88 x 146 x 27mm	88 x 146 x 27mm
Weight	175g	175g

SEESNAKE® INTERFACE

Exclusively compatible with Mini-Cam Control Units

Sturdy and robust construction, the Mini-Cam SeeSnake® Interface unit quickly and easily connects the Rigid® SeeSnake® Standard and SeeSnake® Mini cameras to Mini-Cam's intuitive and advanced Proteus Control Units.

RIDGID



Also available to fit Mini-Cam SOLOPro+ Control Units Product Code: SSP02

Technical Specifications

Product Code	SSP01
Compatibility	Proteus Control Unit
Dimensions WxLxD	50 x 268 x 40mm
Weight	115g

BRICK EGG STABILIZER

Eliminates rolling over of the crawler

A simple quick fit to our Proteus Crawler, the *Brick Egg Stabilizer* stops the crawler from rolling over during inspections in pipes with an egg-shaped profile. Exclusively compatible with Mini-Cam's Proteus CRP300, CRP150, CPL150 and CRP140 crawlers.

Compatibility:
BEP300 fits Proteus CRP300
BEP150/140 fits Proteus CRP150, CPL150 and CRP140

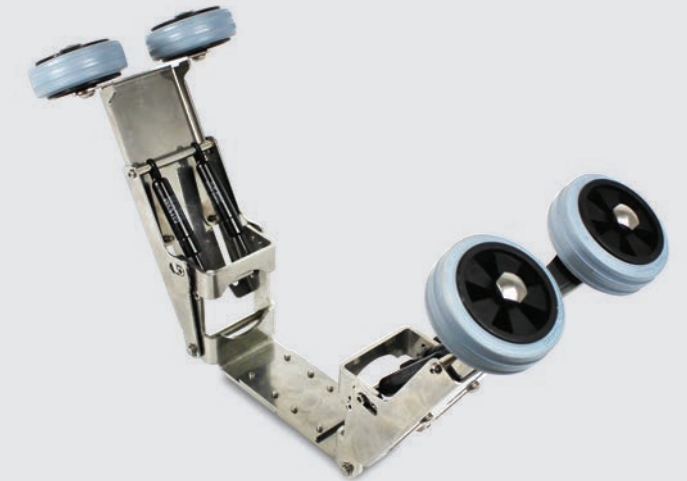
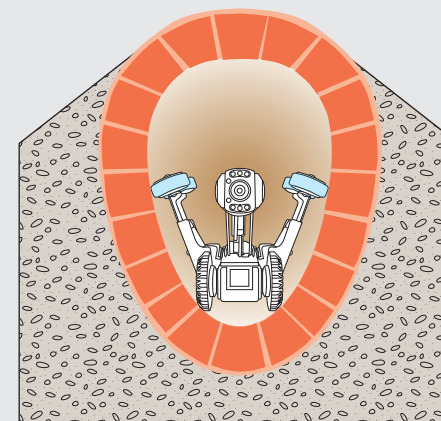

Technical Specifications

Product Code	BEP300
Compatibility	CRP300
Dimensions LxWxH	450 x 190 x 220mm
Weight	2.95kg

Technical Specifications

Product Code	BEP150/140
Compatibility	CRP150/CPL150/CRP140
Dimensions LxWxH	375 x 180 x 210mm
Weight	2.05kg

CABLE REEL GUIDE

Smooth friction-free cable guiding

Reduces friction and provides additional guidance for the cable when paying out and rewinding. Also brushes and cleans the cable when rewinding. Exclusively compatible with Mini-Cam Motorised and Manual 300 metre and 200 metre Cable Reels.



Technical Specifications		
Product Code	CGP300	CGP200
Compatibility	RAP300 / RMP300	RAP200 / RMP200
Dimensions LxWxH	540 x 490 x 175mm	540 x 370 x 175mm
Weight	3.5kg	2.9kg

VAN GUIDE PULLEY

Smooth friction-free cable guiding

Reduces friction and provides additional guidance for the cable when paying out and rewinding. Exclusively for use with Mini-Cam Motorised and Manual, 300 metre and 200 metre Cable Reels.



Technical Specifications	
Product Code	VGP01
Compatibility	RAP300/200 & RMP300/200

CAMERA ELEVATION PLATFORM

Increase your inspection capabilities

This telescopic elevator quickly attaches to the CRP300 Crawler and can be manually moved up or down to increase inspection capabilities up to 2200mm. Interface for cameras and auxiliary lights.

Technical Specifications	
Product Code	CEP300
Connections	Camera connection (front) Lifter connection (rear) 2 x additional lamp connections (side) 1 x additional lamp connection with Backeye Camera (top connector)
Top camera position	1090mm Top camera position (pipe centre) using pneumatic balloon wheels
Mid camera position	Approx 830mm Mid camera position (pipe centre) with extended plate
Low camera position	565mm Low camera position (pipe centre) with pneumatic wheels
Dimensions L x W x H	142 x 130 x 476 mm
Weight	5.7kg



REEL BRACKET

Use the reel as a CCU holder, for portability in remote areas

This lightweight tubular bracket is quick and easy to attach, using the bolts and washers supplied. The bracket holds the control unit firmly in place in a comfortable working position for the user. Available in 2 sizes.



Technical Specifications

Product Code	RBP01	RBP02
Compatibility	Fits 200m Reel	Fits 300m Reel
Dimensions LxWxH mm	350 x 215 x 118	430 x 215 x 118
Weight (inc fixings)	675g	735g

PRESSURE KIT

All you need to purge a Proteus crawler and camera head

Pressurisation is safe, quick and easy. Two kits are available: Standard CO₂ and a Nitrogen version for ATEX equipment. Supplied in a handy padded carry case.

Replacement cylinders can be purchased separately.



Technical Specifications

Product Code	Description
PKP01	Standard CO ₂ Pressure Kit
PKP02EX	ATEX Nitrogen Pressure Kit

PRO LASER

Pinpoint accurate laser profiling of pipes and sewers

ProLaser is the perfect partner for any CCTV inspection system and provides accurate analysis of the true pipe condition prior to and after rehabilitation.

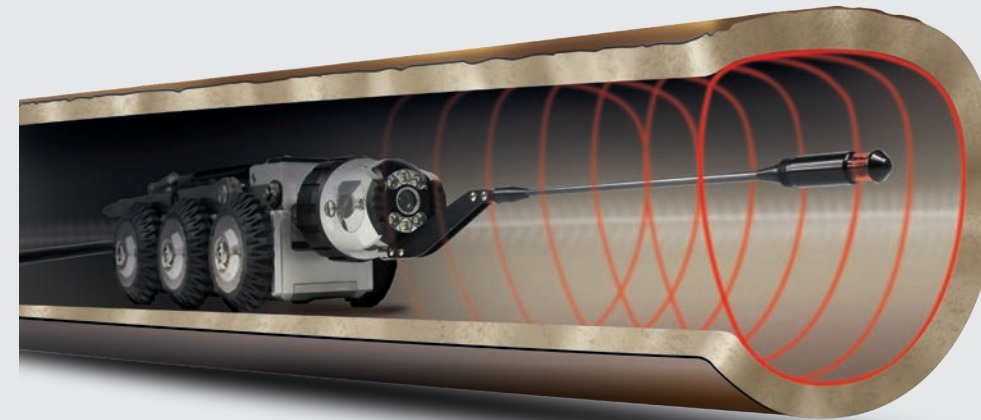

Data Analysis and Delivery

The Mini-Cam Laser profiler has been designed to provide accurate and repeatable pipe geometry for many pipeline conditions. Simply attach the device to your CAM026 and WinCan will do the rest! All results are automatically calculated and can be delivered via WinCan. The WinCan software generates the report automatically, including diameter, ovality, capacity and also provides 3-dimensional XYZ-data.

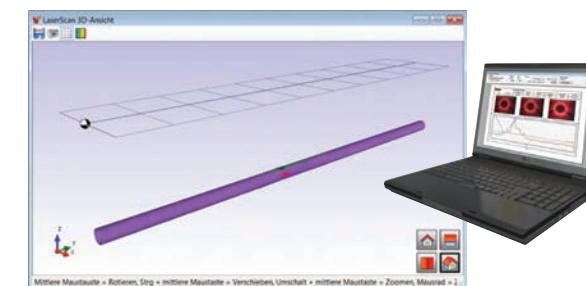

WHY DO YOU NEED A PIPE PROFILER?

If you are a municipality, consulting engineer or contractor, the Profiler is a necessary tool for the analysis of the true pipe condition prior to and after rehabilitation. When used as a video survey tool it can provide accuracy up to 1mm when measuring pipe size, deformation, erosion encrustation, debris, grease, flows, lateral protrusion, surface damage and holes.

CRAWLERS • CCU • REEL

		CRP300	CRP150	CRP140	CRP90	
CRAWLERS	Pipe Diameter	300 - 1000mm	150 - 600mm	140 - 600mm	90 - 225mm	
	Weight	32 kg	9.25 kg	9.25 kg	4.5 kg	
	Pressure Depth Rating	1 bar (14.50psi)	1 bar (14.50psi)	1 bar (14.50psi)	1 bar (14.50psi)	
	Built-in Elevator	Motorised	Manual	Motorised	Motorised	
	Quick Change Wheel Lock	■	■	■	■	
	Optional Large Wheels	3 size options	4 size options	4 size options	2 size options	
	Multi-Frequency Sonde Transmitter	■	■	■	■	
	Inclination Sensor	■	■	■	■	
	Heavy Duty Connector	■	■	■	■	
	Flexible Rear Connector	□	□	■	■	
Dimensions	L x W x H mm	470 x 233 x 195	307 x 133 x 110	386 x 133 x 108	296 x 87 x 72	
ATEX Zone 2 Certified	Ex	□	□	□	□	
CCU208	Operating System	Linux	■	■	■	■
	Screen	XGA (1024 x 768 pixels) Daylight Viewable	■	■	■	■
	Interfaces	RS232, USB 2.0				
	Internal Storage	Internal Solid State				
	External Storage	2 x USB 2.0 /SDHC				
	File Format	MPEG-4 / JPEG Stills				
	Weight	5.5 kg (12.12lb)				
Dimensions	L x W x H mm L x W x H inches	430 x 280 x 150 16.9 x 11 x 6	430 x 280 x 150 16.9 x 11 x 6	430 x 280 x 150 16.9 x 11 x 6	430 x 280 x 150 16.9 x 11 x 6	



RMPL250 REEL	Construction	Welded Steel	■
	Finish	Powder Coated	■
	Distance Counter Units	Feet, Metres	■
	Controls	Friction Brake	■
	Weight		29.3kg
	Dimensions	(L x W x H) cm	550 x 385x 700

CPL150 CRAWLER	Pipe Diameter	150 - 400mm	■
	Pressure Depth Rating	1 bar (14.50psi)	■
	Built-in Elevator	Manual	■
	Quick Change Wheel Lock		■
	Optional Large Wheels	4 size options	□
	Multi-Frequency Sonde Transmitter		□
	Inclination Sensor		□
	Heavy Duty Connector		■
	Weight		9.25 kg
	Dimensions	(L x W x H) mm	320 x 85 x 100mm
ATEX Zone 2 Certified	Ex	□	

- Standard
- Optional
- Standard
- Optional



Self Levelling Axial



Pan & Rotate

CAMERAS & AUXILIARY LIGHTS

CAM025	Imager	1/4" colour CCD with DSP (Digital Signal Processor)
	Standard	PAL
	Effective Pixels	512 x 582
	Resolution	470 HTVL
	Sensitivity	< 1.0 lux
	Aperture/Field of View	F2.5 / 75°
	Image Orientation	Auto-levelling
	Dimensions	220 x 41 x 41mm (8.6 x 1.61 x 1.61in)
	Weight	0.617kg (1.36lb)
	Illumination System	4 LED
	Illumination Intensity	Adjustable (to 12.5k lux at 150mm)
	Pressure Depth Rating	1 bar (14.50psi)
	Construction	Stainless Steel
Pipe Compatibility	50mm (2") and up	
Sonde	33 kHz / 512 Hz / 640 Hz	
Pipe Adaptor Kit	3" / 4" / 6" Skids	

CAM026	Imager	1/4" colour CCD with (Digital Signal Processor)
	Standard	PAL
	Effective Pixels	512 x 582
	Resolution	470 HTVL
	Sensitivity	< 1.0 lux
	Aperture/Field of View	F2.5 / 75°
	Image Orientation	Auto-levelling
	Dimensions	120 x 74 x 74mm (4.7 x 2.9in x 2.9in)
	Weight	0.864kg (1.90lb)
	Illumination System	6 LED
	Illumination Intensity	Adjustable (to 12.5k lux at 150mm)
	Pressure Depth Rating	1 bar (14.50psi)
	Construction	Aluminium / Stainless Steel
Pipe Compatibility	100mm (6") and up	
Sonde	33 kHz / 512 Hz / 640 Hz	
Pipe Adaptor Kit	6" / 8" Skids	



Axial



Pan, Rotate & Zoom



Auxiliary Light



Auxiliary Light & Backeye

CAM027	Standard	PAL
	Pressure Depth Rating	1 bar (14.50psi)
	Power consumption	6W
	Dimensions (L x W x H)	62 x 52 x 52mm (2.4 x 2.0 x 2.0in)
	Weight	0.25kg (0.55lb)

CAM028	Standard	PAL
	Pressure Depth Rating	1 bar (14.50psi)
	Power consumption	
	Zoom	10x optical 12x digital
	Lasers	Twin
	Dimensions (L x W x H)	143 x 80 x 80mm (5.6 x 3.1 x 3.1in)
Weight	1.15kg (2.2lb)	

ALN300	Standard	PAL
	Pressure Depth Rating	1 bar (14.50psi)
	Power Consumption	6W
	Dimensions (L x W x H)	51 x 68 x 50mm (2.0 x 2.6 x 1.9in)
	Weight	0.23kg (0.5lb)

ALN300 is in-built as standard on the CRP300

ALB300	Standard	PAL
	Pressure Depth Rating:	1 bar (14.50psi)
	Power Consumption:	6W
	Dimensions (L x W x H)	84 x 68 x 50mm (3.3 x 2.6 x 1.9in)
	Weight	0.30kg (0.7lb)



All cameras (except CAM027) above are available in ATEX ZONE 2 approved

SERVICE SUPPORT FOR JUST WHEN YOU NEED US MOST

Mini-Cam's reputation for efficient, quality service is now mobile nationwide*. Our dedicated, highly skilled service technicians are available to offer routine maintenance and emergency repairs, both on-site and at your depot.

Our Service Support vehicle is stocked with a range of replacement parts and fault finding equipment that will cover most eventualities. Mini-Cam customers who need an urgent repair, can take advantage of this service.

- Competitive Pricing
- Rapid Service Turn-Around
- Loan equipment provided** whilst yours is repaired on-site
- Replacement parts readily available
- Minimize downtime



SERVICE SUPPORT LINE

For further information and to request a Service Support visit please contact:
Glenn Guest - Service Manager
Office: 01942 270524
8am – 5pm Monday to Friday
Email: servicevan@minicam.co.uk

*Service Support coverage is Mainland UK only and does not include Scottish Highlands, Scottish Islands, Isle of Wight, Isle of Man, Dublin, Eire, Channel Islands.**Subject to availability.

AFTER SALES SUPPORT WE ARE RIGHT BEHIND YOU ALL OF THE WAY!



At Mini-Cam we pride ourselves on our commitment to always going the extra mile with our customer care.

After sales support and Service and Repair is available from 8am until 5pm Monday to Thursday, and 8am until 3.45pm on Friday.

Operator and Service Training is available to customers and their employees, at our UK headquarters, your company headquarters or your preferred location - contact us for full details and costs.

PARTS E-SHOP QUICK, EASY ONLINE ORDERING AND WORLDWIDE DELIVERY*

Appointed Mini-Cam Partners are given access to the online parts shop which has the full range of genuine Mini-Cam spares and accessories, all available to order online with same day despatch if ordered before 3pm*. The e-shop stocks parts for all Mini-Cam systems and equipment. www.minicam.co.uk

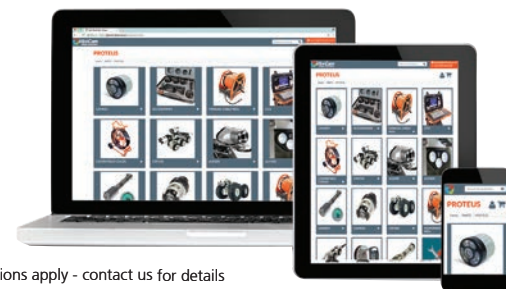

*Terms and conditions apply - contact us for details



HOW TO FIND US



CONTACT INFORMATION

Head Office • Production • Service & Repair

Postal Address
Mini-Cam Limited
Unit 4, Yew Tree Way, Stonecross Park, Golborne,
Warrington, Cheshire, WA3 3JD, United Kingdom

Switchboard
Telephone +44 (0) 1942 444555
Facsimile +44 (0) 1942 273735

Hours of Business
Mon - Thur 8.00am - 5.00pm • Fri 8.00am - 3.45pm
Saturday & Sunday Closed

General Enquiries
Email info@minicam.co.uk

Service Enquiries
Email service@minicam.co.uk

UK Sales
Email greg.guest@minicam.co.uk
Email matthew.stark@minicam.co.uk

International Sales
Email sven.breitenfeld@minicam.co.uk

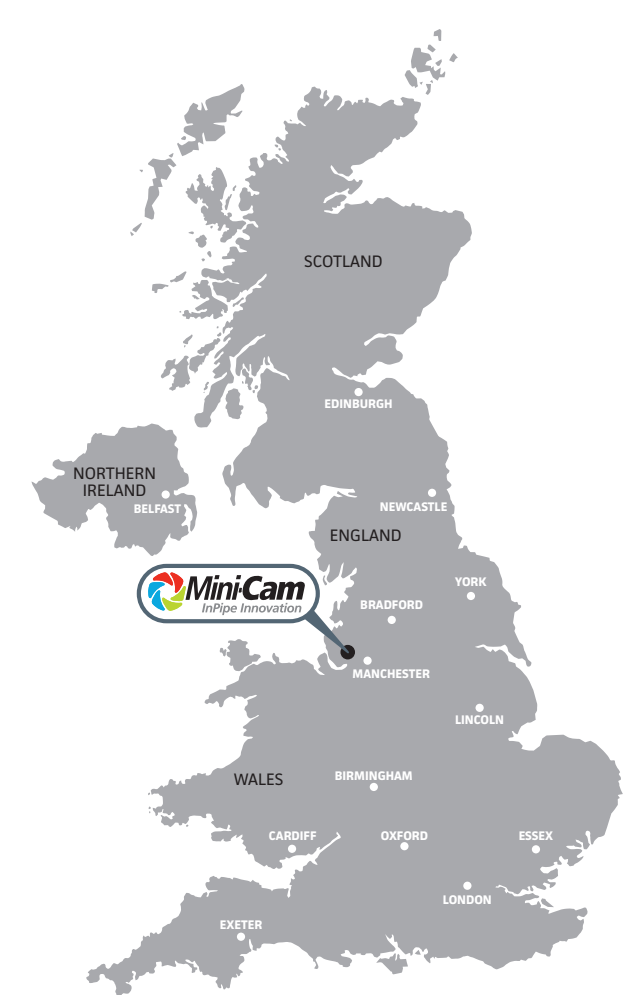

Demonstration Showroom & Custom Van Fits

5 minute drive from our Head Office

Postal Address
Mini-Cam Limited
Innovation House, Unit C, Kirkstead Way,
Golborne, Warrington, WA3 3PY, United Kingdom

Telephone +44 (0) 1942 444555

Custom Van-Fit Enquiries
Email greg.guest@minicam.co.uk
Email matthew.stark@minicam.co.uk

Mini-Cam Ltd. Registered in England & Wales No.3728693. Registered Office: Unit 4, Yew Tree Way, Stonecross Park, Golborne, Warrington, WA3 3JD.
VAT Registration No. GB 218 688 471 ©2018 Mini-Cam Ltd. All rights reserved. Proteus and Mini-Cam names and logos are trademarks of Mini-Cam Ltd.
WinCan Embedded and WinCan Web name and logo are trademarks of CD-Lab and used under licence. Specifications subject to change without notice. Images for illustration purpose only.



Para más información visite

www.corsusa.com

O escríbanos a

info@corsusa.com

Teléfonos +51.1.3990400 +51.1.3990422



Mini-Cam Limited

www.minicam.co.uk



A HALMA COMPANY

